

C03-50A Series Current Sensor

The C03-50A series current sensor provides efficient and precise sensor solutions for AC, DC and pulse currents in industrial, commercial and communications systems. It consists of three main components: an accurate low-temperature drift linear hall sensor, a flux collector and a current transformer. It offers markedly low resistance, reducing power loss and temperature drift to deliver exceptional performance.

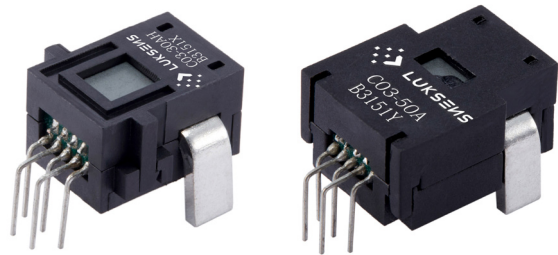

Features

- Non-contact measurement of high current
- Output voltage proportional to carried current
- Max. measuring range $\pm 85\text{A}$ (DC or AC peak)
- High sensitivity up to 40 mV/A
- Ratio metric output from supply voltage
- Nearly zero magnetic hysteresis
- Superior temperature stability and linearity
- High frequency bandwidth 240kHz
- Compact size for applications with limited space
- RoHs compliance (Lead-Free)

Applications

- Home appliances
- Load detections and managements
- Intelligent power/battery management systems
- Welding applications
- Variable speed drives

Advantages

- Accurately measures AC, DC and pulse currents
- Fast response $3\mu\text{s}$, minimal noise output
- No insertion losses
- High immunity from external interference
- Excellent current overload capacity
- High ESD sensitivity (Human Body Model) 4kV

Standards

- EN 50178:1997
- IEC 60950-1:2006
- IEC 61010-1:2010

Absolute maximum ratings

Symbol	Parameter	Min.	Max.	Unit
$V_{DD\ max.}$	Maximum supply voltage (not destructive)	-0.3	7	V
I_{PM}	Maximum measuring current	-85	85	A
$I_{OUT\ max.}$	Maximum output current		10	mA
T_A	Ambient operating temperature	-40	100	°C
T_S	Storage temperature range	-40	125	°C
$V_{ESD-HBM}$	ESD sensitivity HBM (Human Body Model)		4	kV

Stresses above these ratings may cause permanent damage. Exposure to absolute maximum ratings for extended periods may degrade reliability.

Specifications ($T_A = 25^\circ\text{C}$, $V_{DD} = 5.0\text{V}$)

Symbol	Parameter	Test condition	Min.	Typ.	Max.	Unit
V_{DD}	Supply voltage		4.5	5	5.5	V
I_C	Current consumption	$I_P=0\text{A}$ without load		13	15	mA
V_O	Zero current output voltage	$I_P=0\text{A}$ @ $T_A=25^\circ\text{C}$		$V_{DD}/2$		V
I_{PN}	Current nominal measuring range	C03-50A, C03-50AH	-85	± 50	85	A
		C03-50AH40		± 50		
R_L	Output load resistance	V_{OUT} to GND	4.7	10		k Ω
C_L	Output load capacitance	V_{OUT} to GND			10	nF
G	Nominal sensitivity (C03-50A, C03-50AH)	$V_{DD}=5\text{V}$	24.5	25	25.5	mV/A
G	Nominal sensitivity (C03-50AH40)	$V_{DD}=5\text{V}$	39.2	40	40.8	mV/A
V_{OE}	Offset voltage	$I_P=0\text{A}$	2.48	2.5	2.52	mV
T_{CVOE}	Temperature coefficient of V_{OE}	$T_A=-30\dots 100^\circ\text{C}$	-0.075	0.05	0.075	mV/K
T_{CVOUT}	Temperature coefficient of V_{OUT}	$T_A=-30^\circ\text{C} \dots 100^\circ\text{C}$ (except T_{CVOE})	-1.5	1	1.5	%
ϵ_L	Non-linearity error	$\pm I_{PN}$ without offset	-0.8	0.5	0.8	%/ I_{PN}
BW	Frequency bandwidth (-3dB)			120	250	kHz
T_R	Step response to 90% I_{PN}	(Design target)		3	5	μs
$R_{PRIMARY}$	Primary conductor resistance	$T_A=25^\circ\text{C}$		1		m Ω

Insulation characteristics

Symbol	Parameter	Value	Unit	Comment
V_o	Insulation voltage for isolation, 50Hz, 1 min	>1500	V	
R_{iso}	Isolation resistance @500VDC	>500	M Ω	
D-CLE	Clearance	13	mm	C03-50A
D-CLE	Clearance	9.6	mm	C03-50AH, C03-50AH40
D-CRD	Creepage distance	13	mm	C03-50A
D-CRD	Creepage distance	9.6	mm	C03-50AH, C03-50AH40

General characteristics

Symbol	Parameter	Value	Unit	Comment
m-HSE	Housing material	V0		Flame retardant UL 94
m-FC	Flux collector material	Mn-Zn ferrite		Superior magnetic permeability
m	Mass	5	grams	C03-50A
	Mass	4	grams	C03-50AH, C03-50AH40

Typical supply current versus ambient temperature

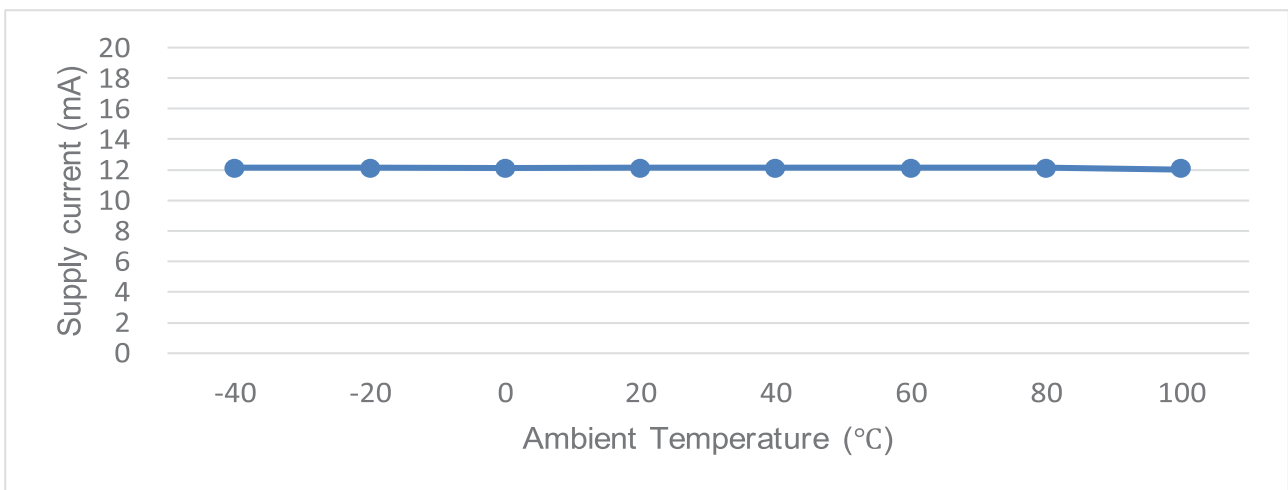

Measured current input versus output voltage

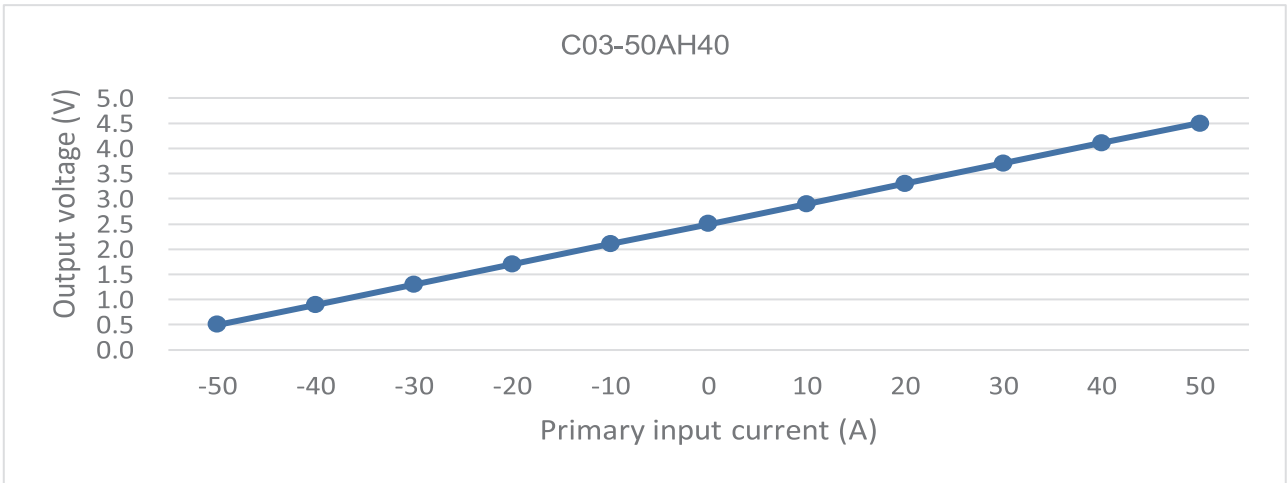
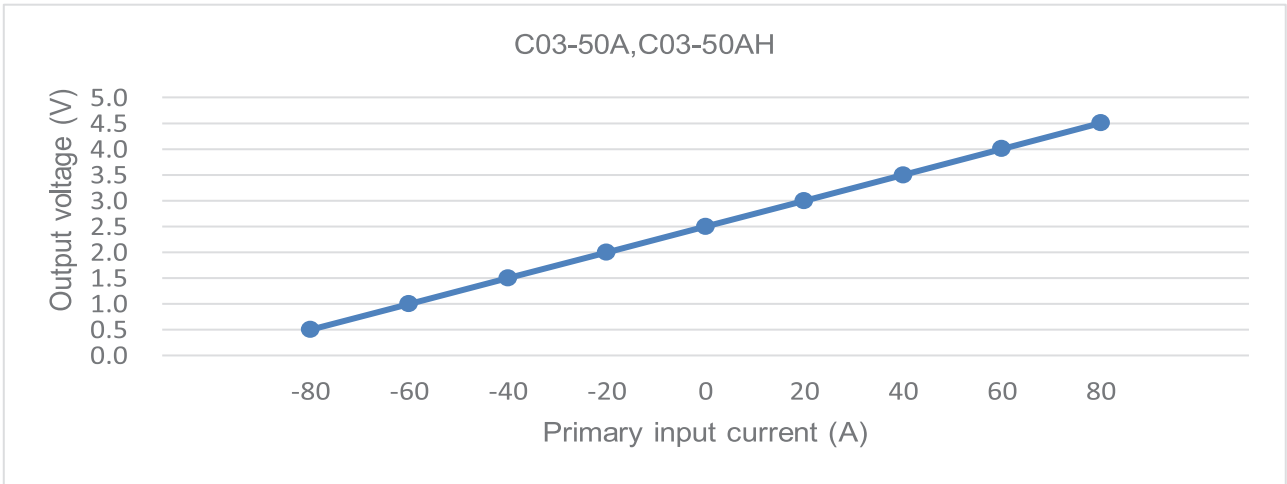

Typical sensitivity drift versus ambient temperature

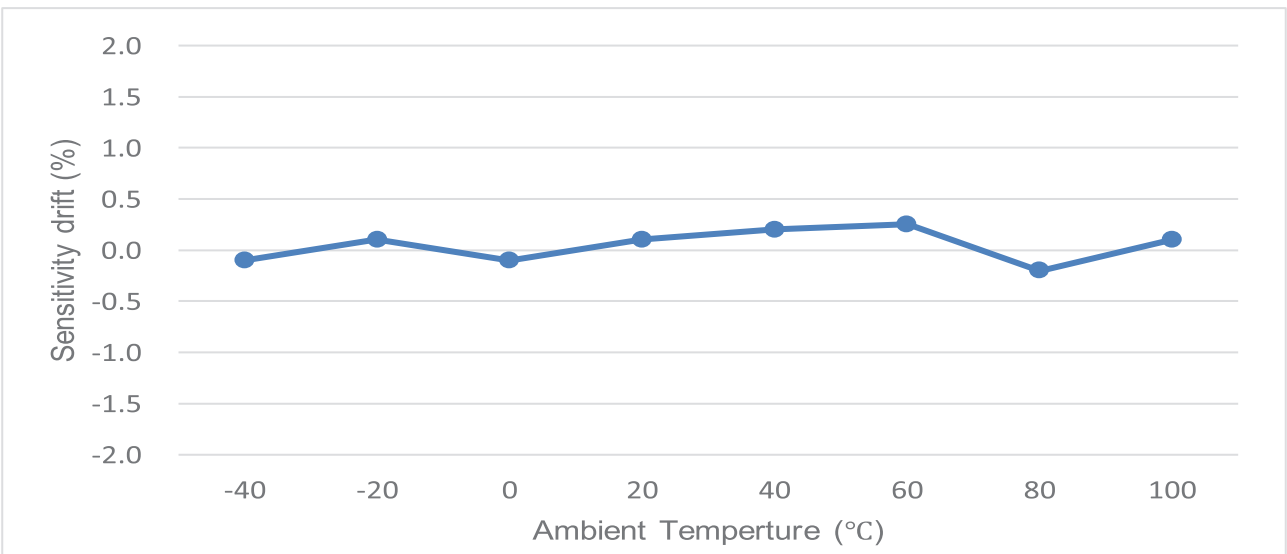

PCB footprint (mm, general tolerance $\pm 0.05\text{mm}$)

C03-50A

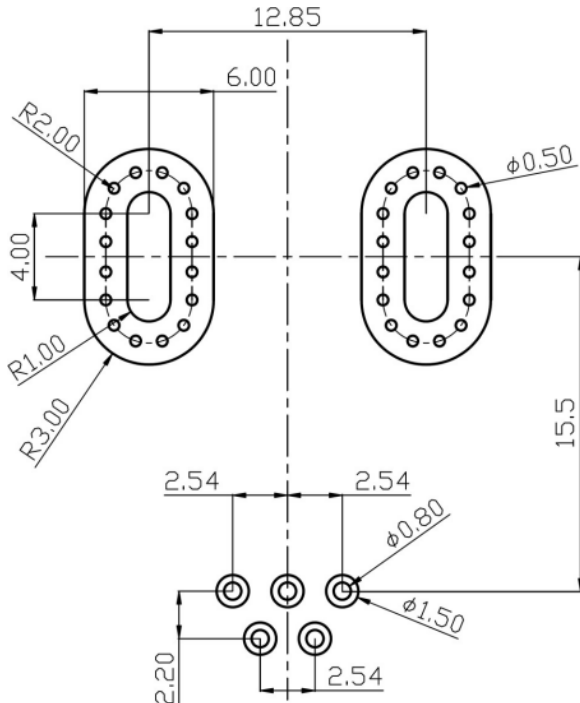

C03-50AH/C03-50AH40

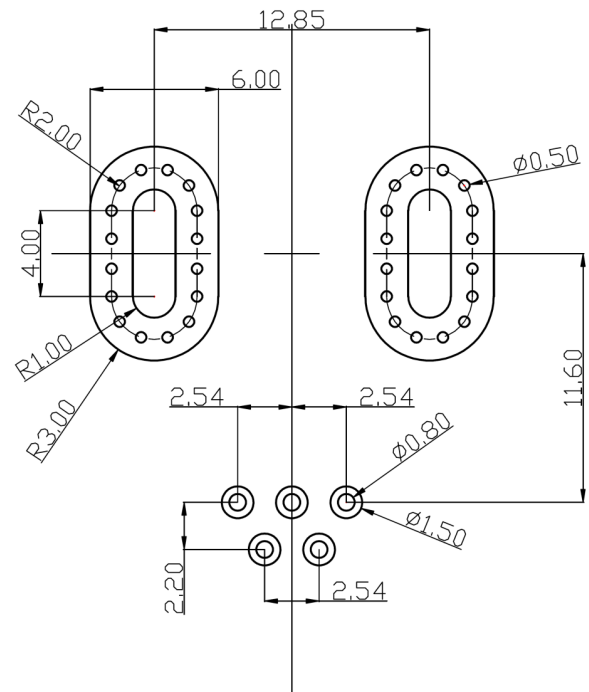

Note:

Maximum soldering temperature 260°C 10s

Maximum PCB thickness 2.4mm

Dimension (mm)

C03-50A

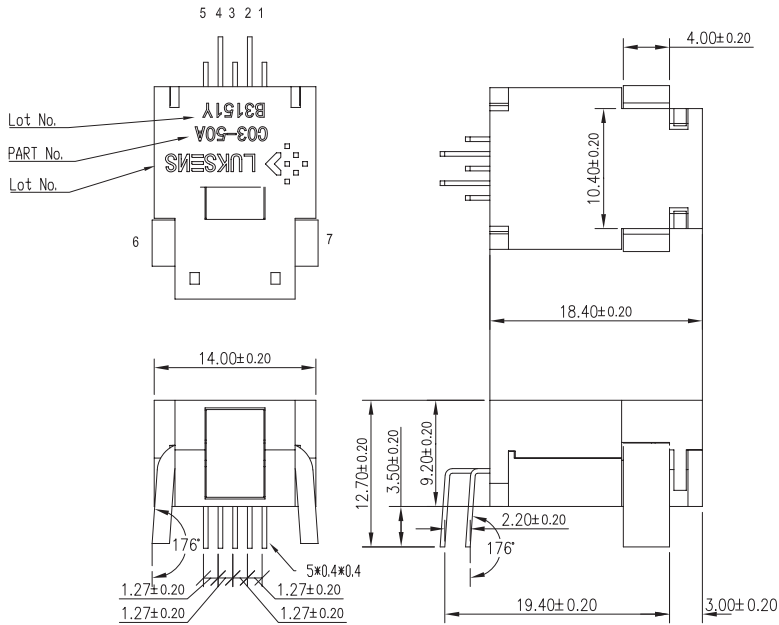

Pin	Symbol
1	TEST-PIN
2	V _{DD}
3	GND
4	V _{OUT}
5	TEST-PIN
6	+I _P
7	-I _P

C03-50AH, C03-50AH40

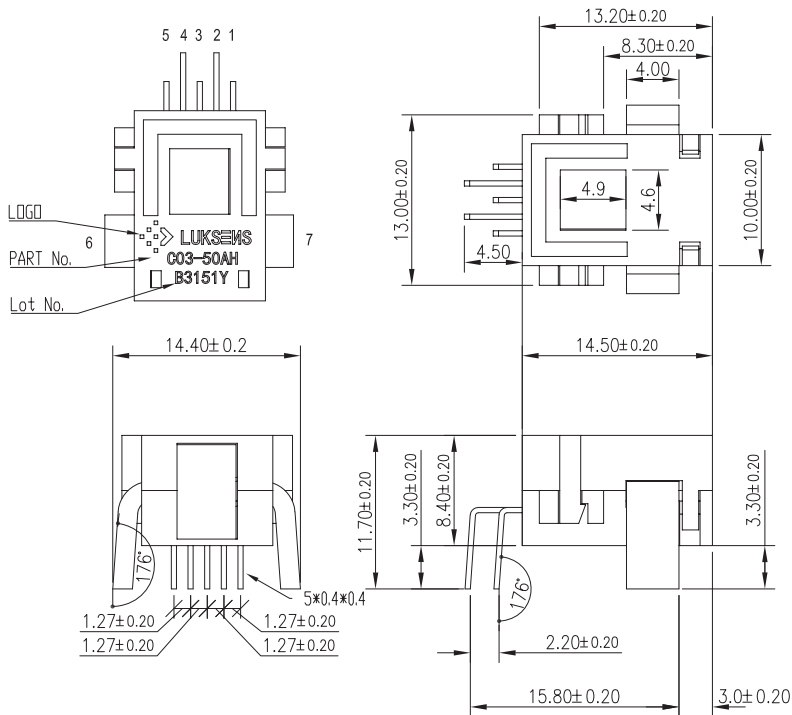

Pin	Symbol
1	TEST-PIN
2	V _{DD}
3	GND
4	V _{OUT}
5	TEST-PIN
6	+I _P
7	-I _P

Name Guide Description

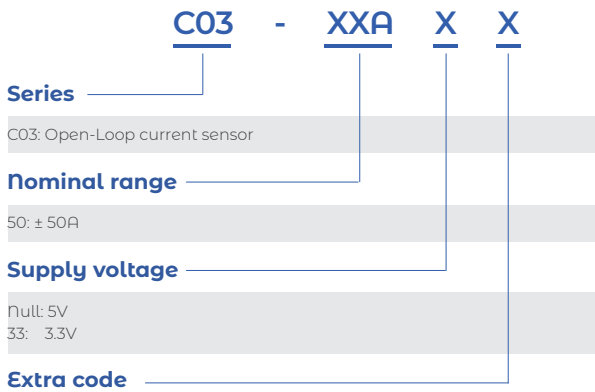

Notes

The content of this document is subject to revision without notice. Luksens shall have no liability for any error or damage of any kind resulting from the use of this document.

Safety and Environment



The product is to be installed by manufacturer trained personnel or competent person trained in accordance with manufacturer installation instructions.

With respect to applicable standards IEC 61010-1/ EN 61010-1 *safety requirements for electrical equipment for measurement, control and laboratory use part 1 general requirements*, the product should be used in limited energy secondary circuits.



Risk of electrical shock

Certain parts of the module can carry hazardous voltage during the operation process of the product because hazardous live voltage of primary conductor, power supply occurs, injury and/or serious damage will be caused if this warning is ignored.

Conducting parts must be inaccessible after installation of the product. Additional protection including shield or protective housing could be used according to IEC 60664 Insulation coordination for equipment within low-voltage supply systems.

Disconnection of the main supply will protect against possible injury and serious damage.



ESD protection

Damage from an ESD event will occur if the personnel is not well grounded when handling.

Important notice

Luksens reserves the right to change the specifications, including all statements and data appearing in Luksens' catalogues, data sheets and advertisements, without notice. Luksens will publish the modified specifications on its website. If such changes to specifications are made, Luksens shall have no obligation to provide the change on Products previously purchased. The information included herein is believed to be accurate and reliable. However, since additional design, measure, production, quality control take effect in the end product, therefore Luksens shall have no liability for any potential hazards, damages, injuries or loss of life resulting from the end product. Luksens products are not to be used in any equipment or system, including but not limited to life support equipment or systems, where failure of Luksens products may cause bodily harm.